

I am a Rook.

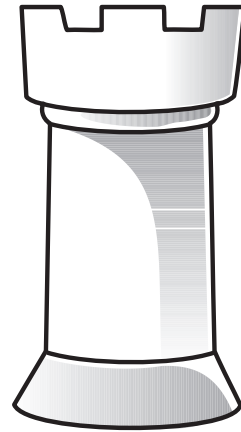

I look like a castle.

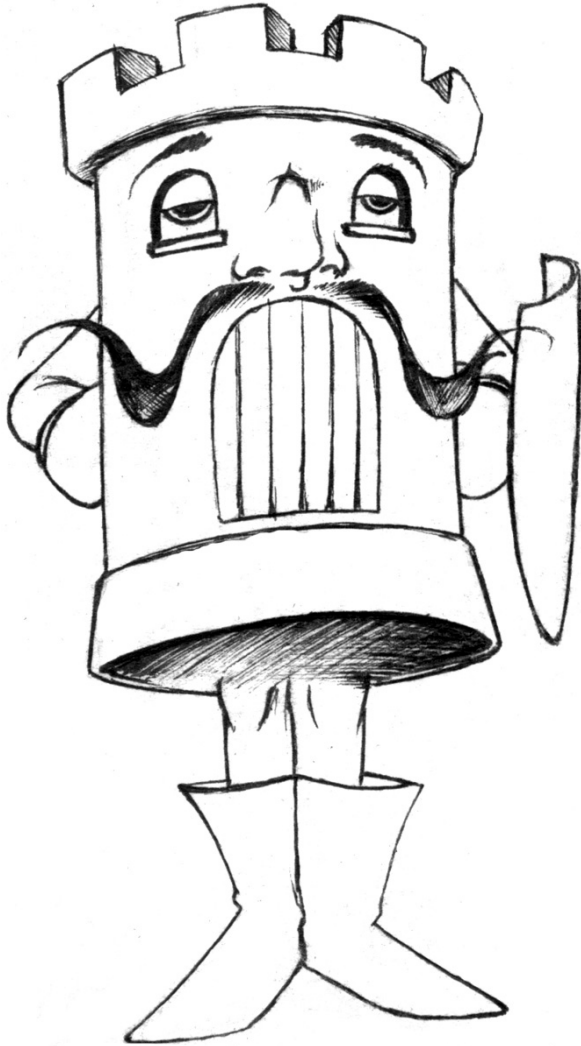
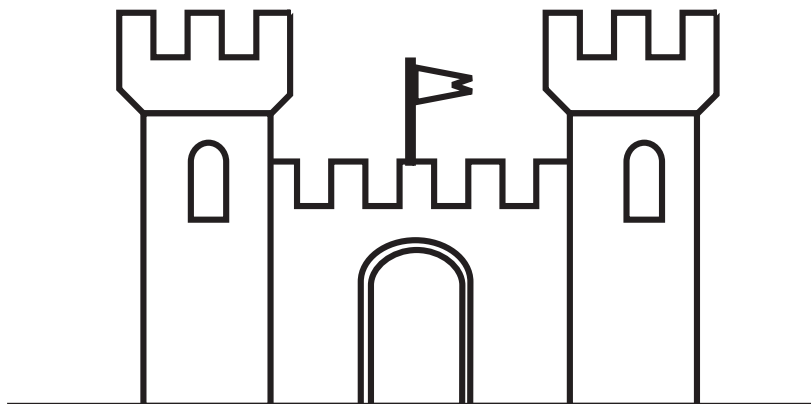

Rooks stand on the corner squares.

Circle the light Rooks on Rank 1.

Circle the dark Rooks on Rank _____ .

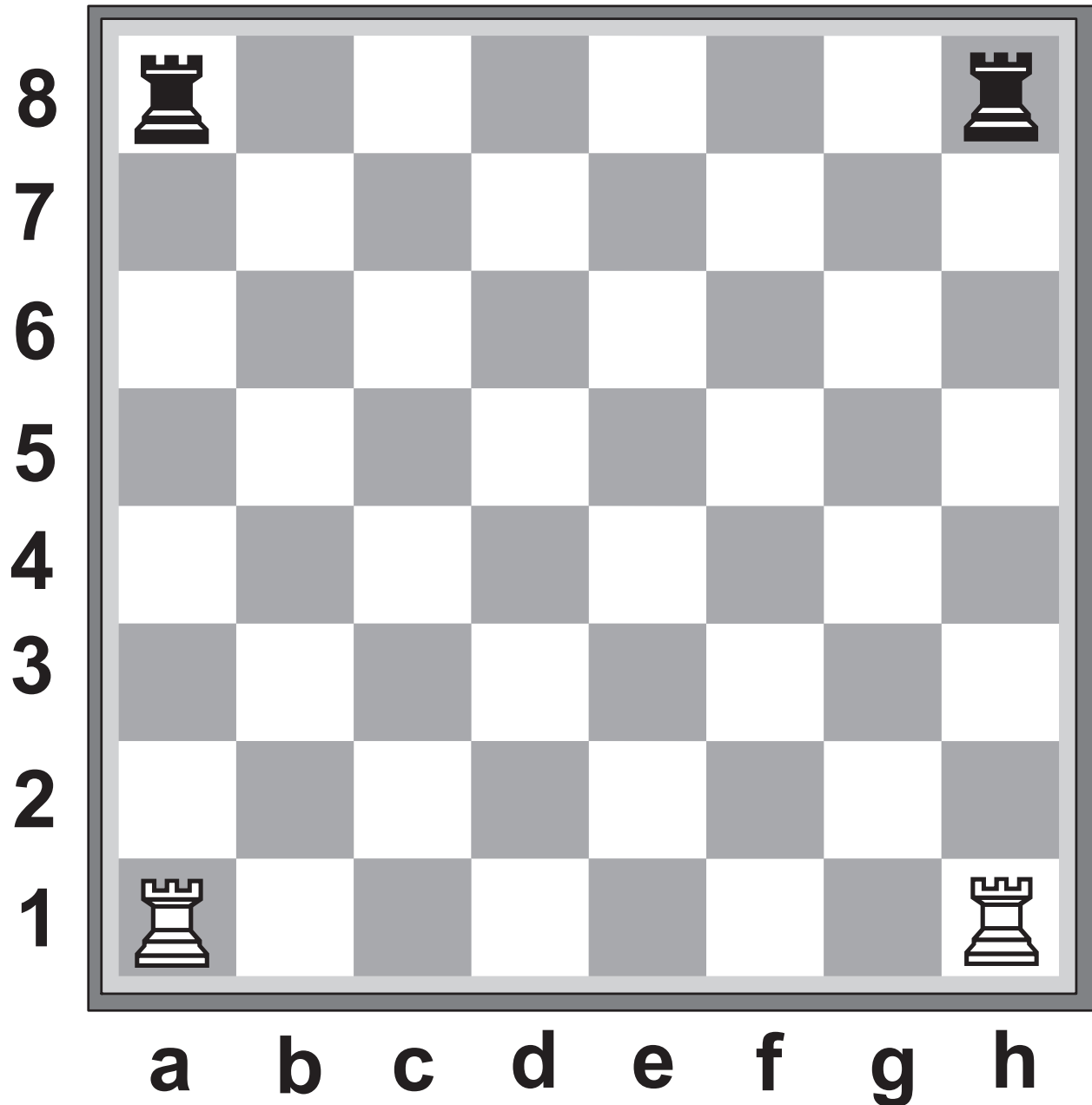

Count the Rooks on the chessboard. _____

I stand tall to protect my army.

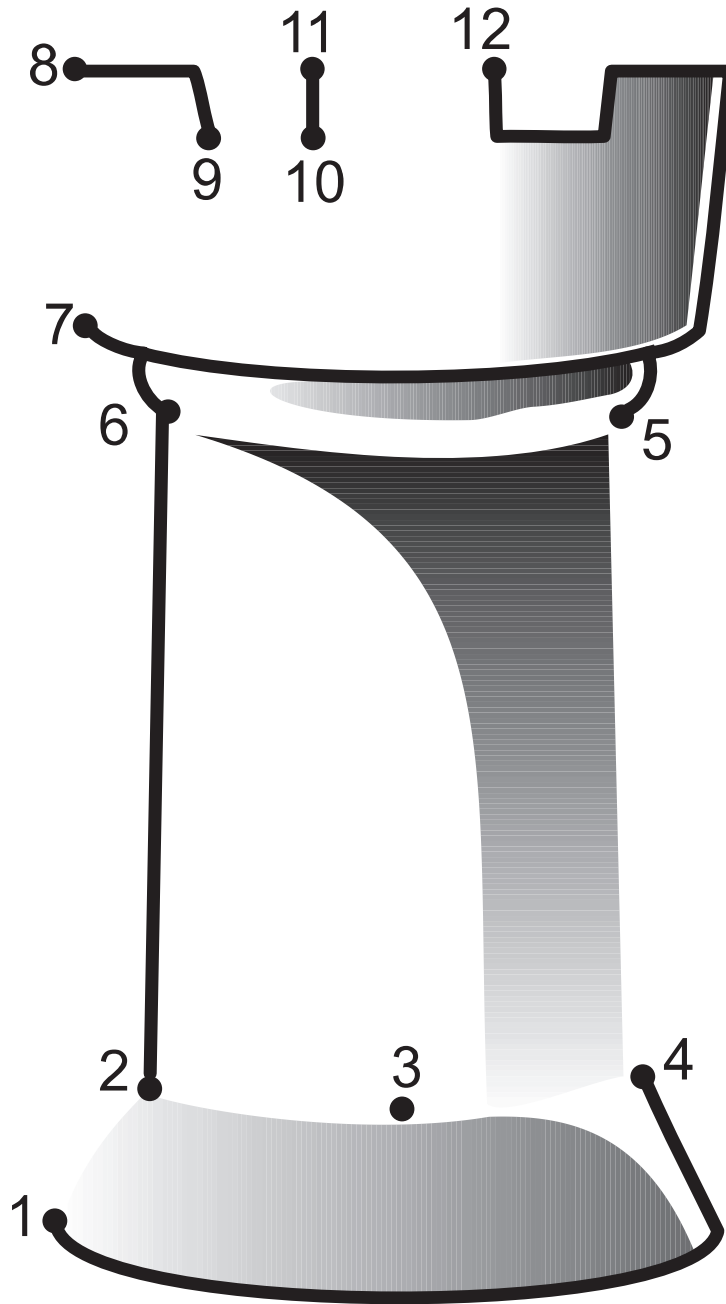

Connect the dots to see me. Color me.

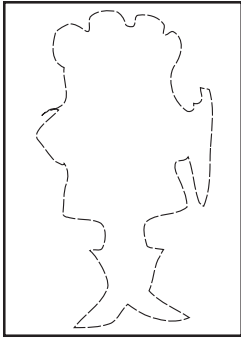

Light Rook

Listen to the CD. Sing and do the Rook with me!

Do the Rook

Start walking forward 'til you can move no more.

Start walking backwards until you hit the door.

Do the Rook, do the Rook.
Do the Rook, do the Rook.

Side step, side step, side step, oh, oh, oh.
Side step, side step, side step, as far as you can go.

Do the Rook, do the Rook.
Do the Rook, do the Rook.

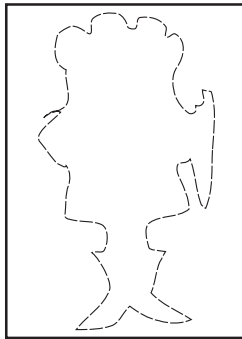

Dark Rook

